



METALÚRGICA SIDERÚRGIA

APRESENTAÇÃO
CORTE E CONFORMAÇÃO DE METAIS

SOBRE NÓS



SOLUÇÕES EM FERRAMENTAS PARA CORTE COM ALTA TECNOLOGIA, QUALIDADE E PRECISÃO

Há mais de 30 anos, o Grupo Hagane se destaca na fabricação de ferramentas como facas, rolos e serras para corte e conformação de metais.

Atuamos com inovação e tecnologias personalizadas para atender diferentes segmentos, abrangendo empresas em todo o Brasil e países da América Latina.

Investimos na qualificação contínua de nossa equipe para garantir excelência e resultados superiores.



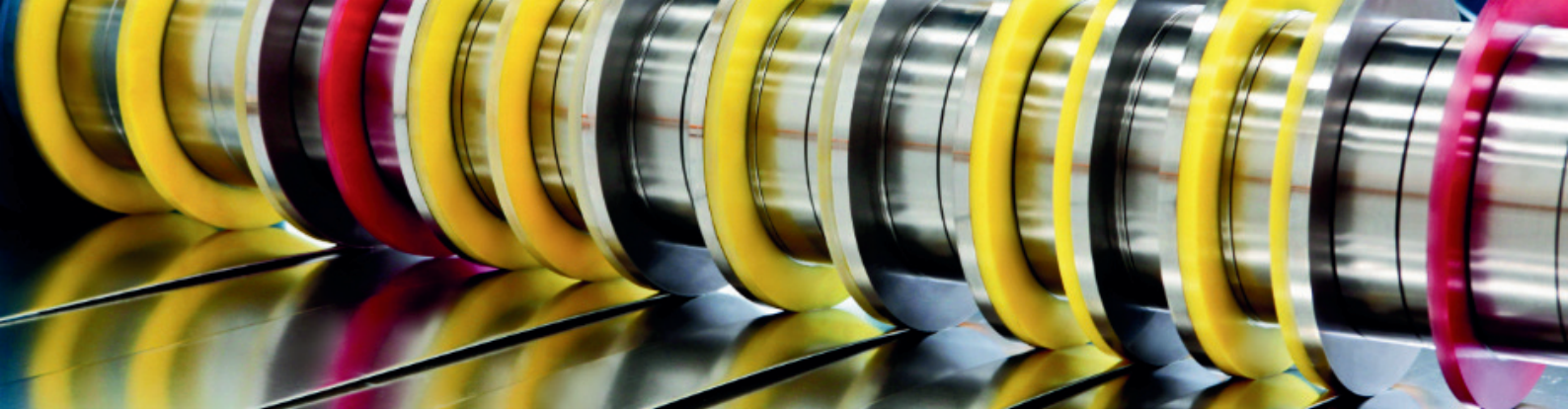

SLITTER

FERRAMENTAL PARA LINHA DE CORTE LONGITUDINAL

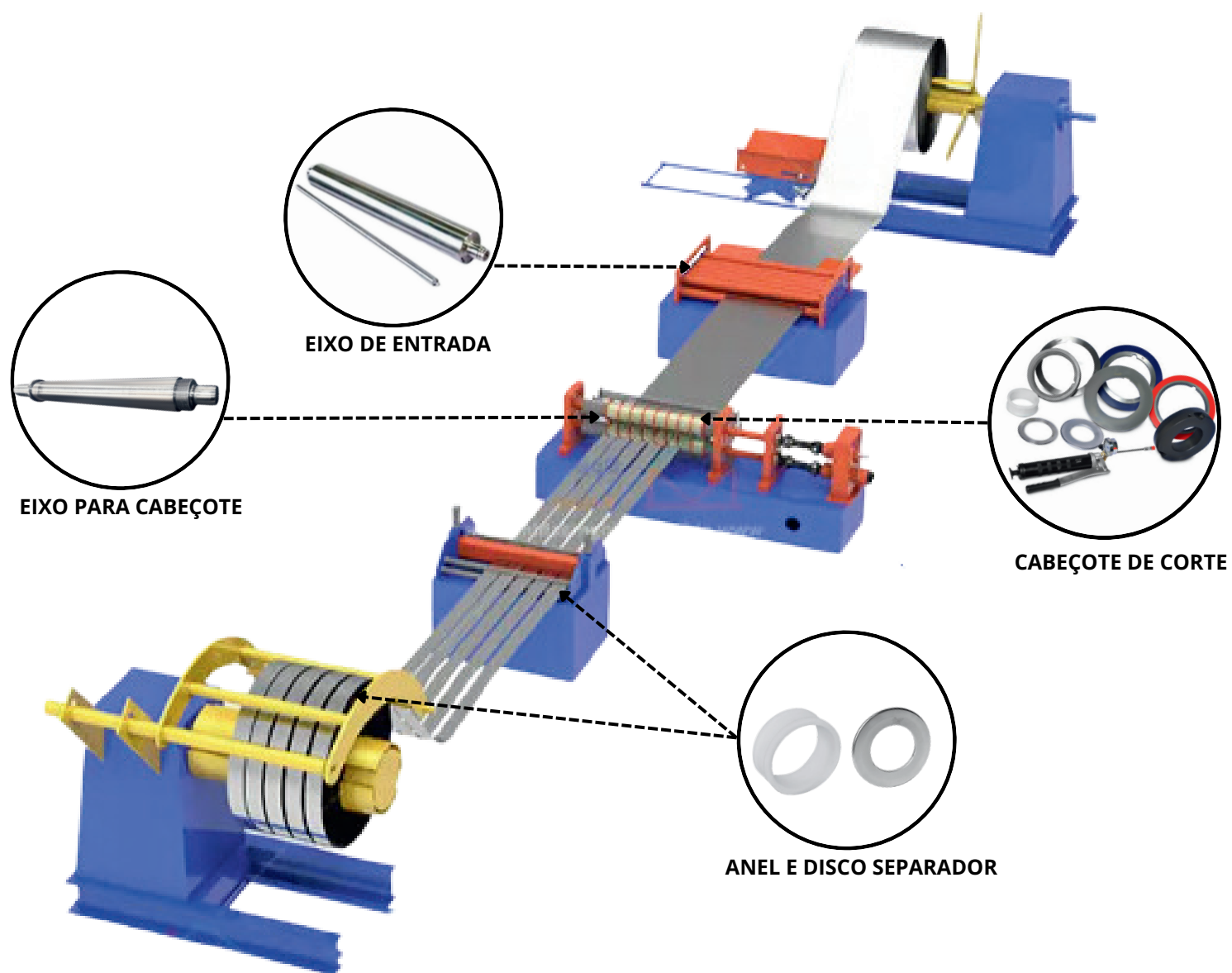

SLITTER

PRODUTOS FABRICADOS PELA HAGANE



FACAS



ANEL EXPULSOR



ANEL SEPARADOR



PORCA E BOMBA HIDRÁULICA

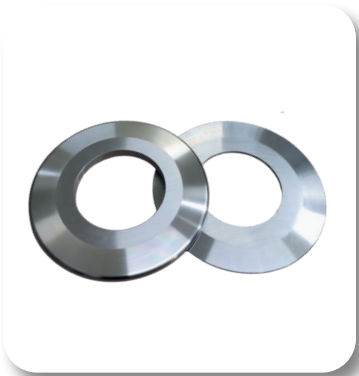

DISCO SEPARADOR DE FITAS



ANEL SEPARADOR DE DISCO



EIXOS



SCL- SOFTWARE DE CORTE LONGITUDINAL



LAPIDADORA

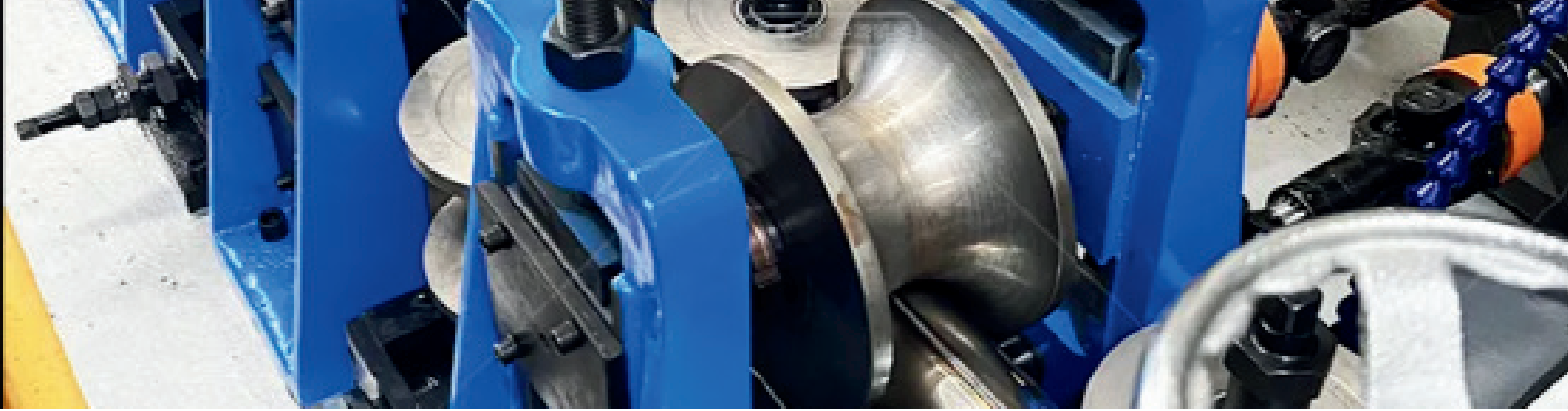

CORTE E CONFORMAÇÃO

FERRAMENTAL PARA MÁQUINAS DE TUBOS



ROLOS DE SOLDA

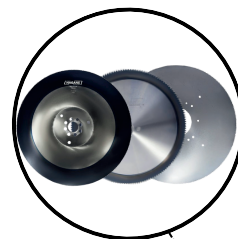

SERRAS CIRCULARES

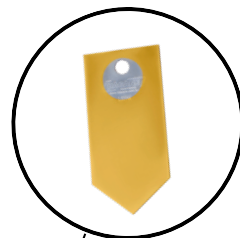

PUNÇÃO

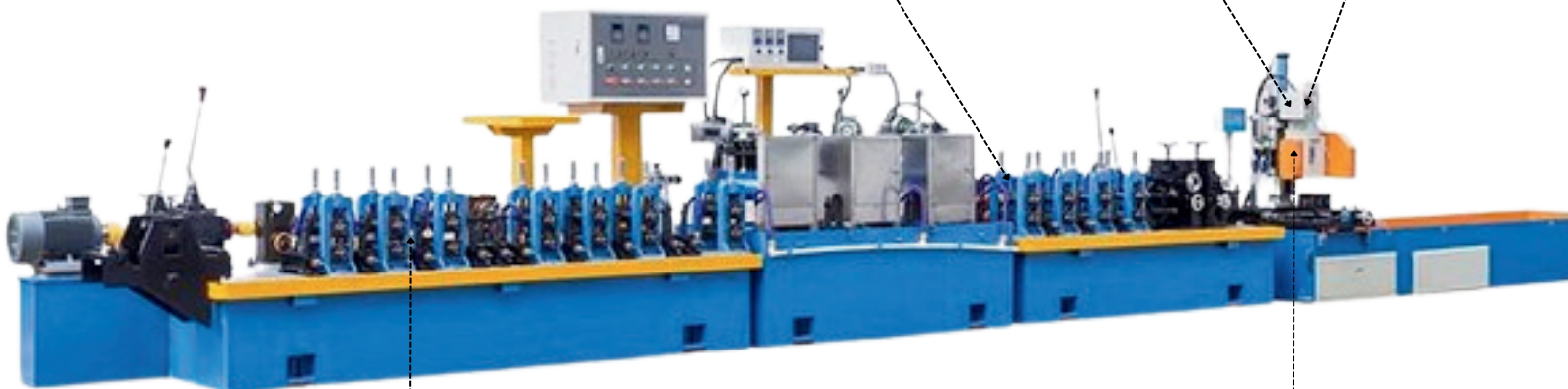

ROLOS DE CONFORMAÇÃO

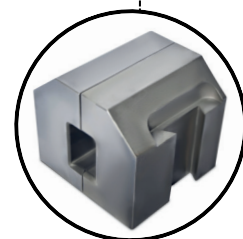

MORDENTE

CORTE E CONFORMAÇÃO

PRODUTOS FABRICADOS PELA HAGANE



ROLOS DE CONFORMAÇÃO



ROLOS DE SOLDA

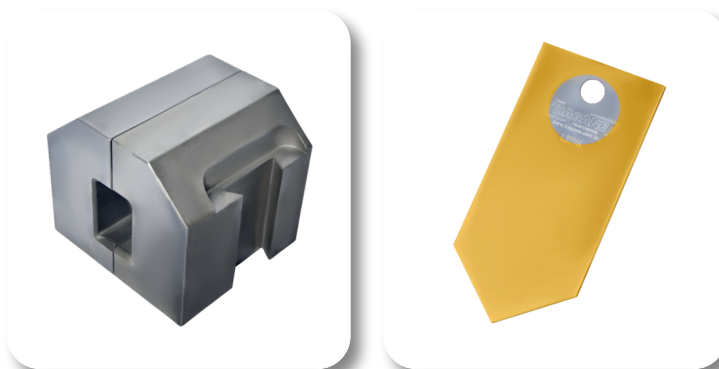

MORDENTES

PUNÇÃO



SERRAS CIRCULARES

CORTE E CONFORMAÇÃO

FERRAMENTAL PARA PERFILADEIRA

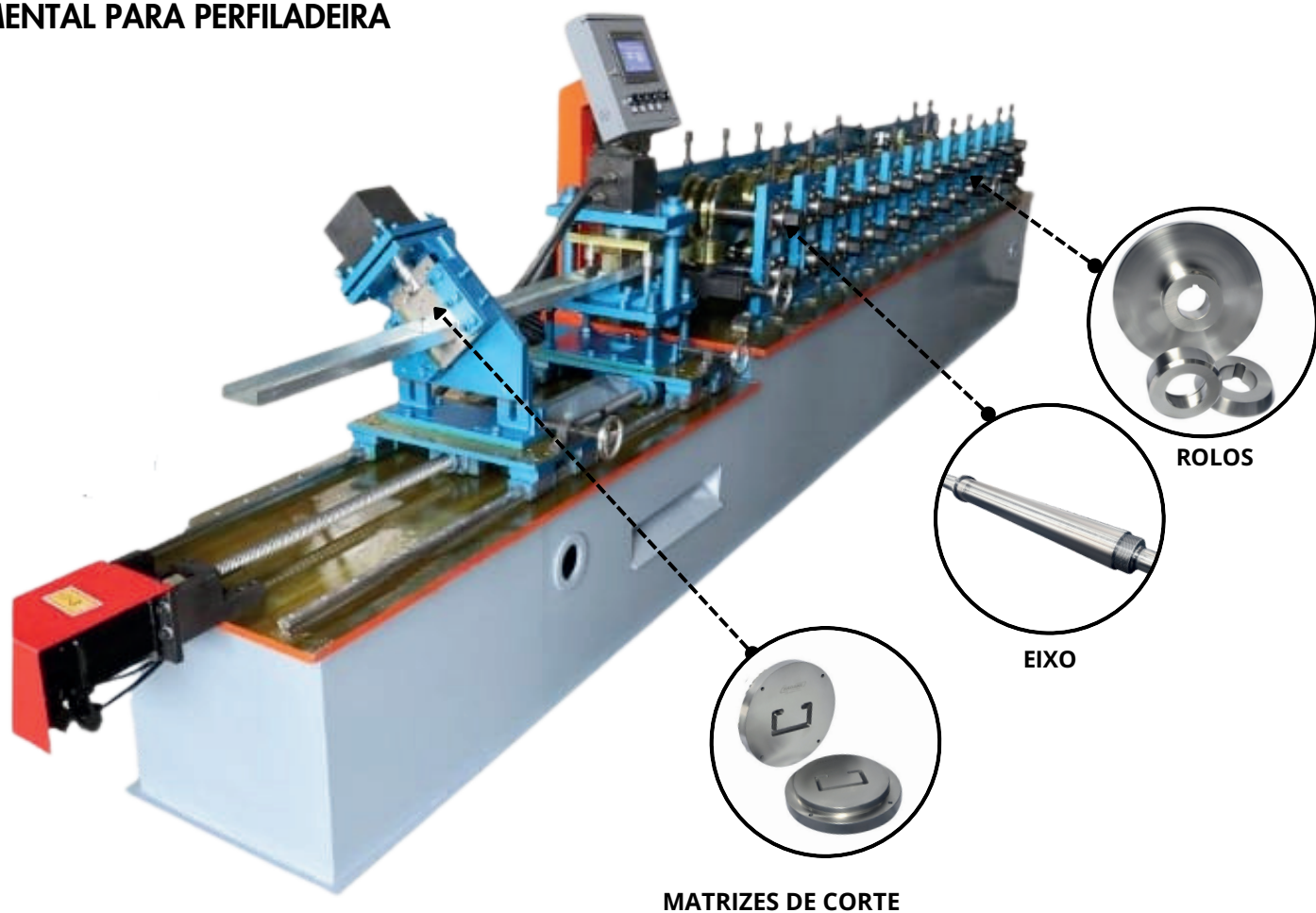

FERRAMENTAL PARA MÁQUINA DE TELHAS

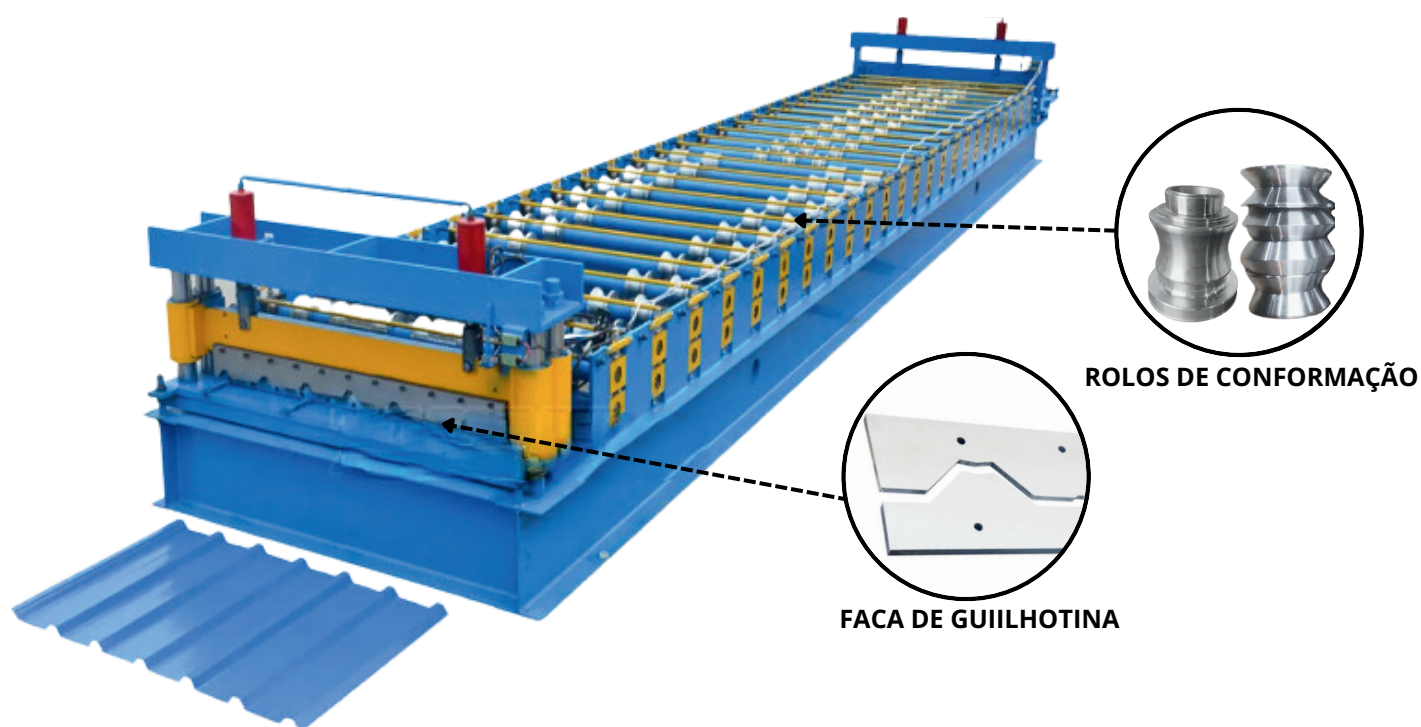

CORTE E CONFORMAÇÃO

PRODUTOS FABRICADOS PELA HAGANE



PERFILADEIRA



ROLOS DE CONFORMAÇÃO



MATRIZES DE CORTE

MAQUINAS DE TELHAS



FACA DE GUILHOTINA PARA TELHA

ROLOS DE CONFORMAÇÃO

LAMINAÇÃO

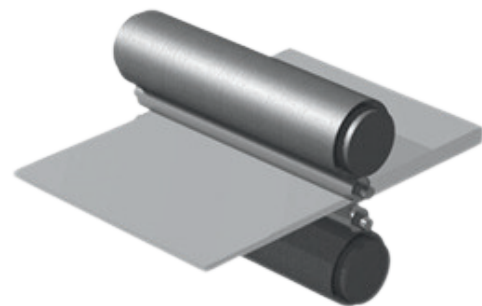

CILINDRO DE LAMINAÇÃO

EIXOS



EIXOS GERAIS E APLANADORES

GUILHOTINA

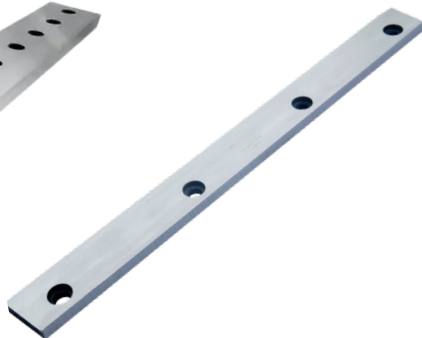

FACAS PARA CHAPAS, BARRAS E CABOS



+55 (11) 2523-7911

+55 (11) 97205-9943

info@hagane.com.br

Rua: Ioneji Matsubayashi, 500 - Jd Colônia - SP

Veja mais

